

GEMINI 300M 2.0

Owner's Manual

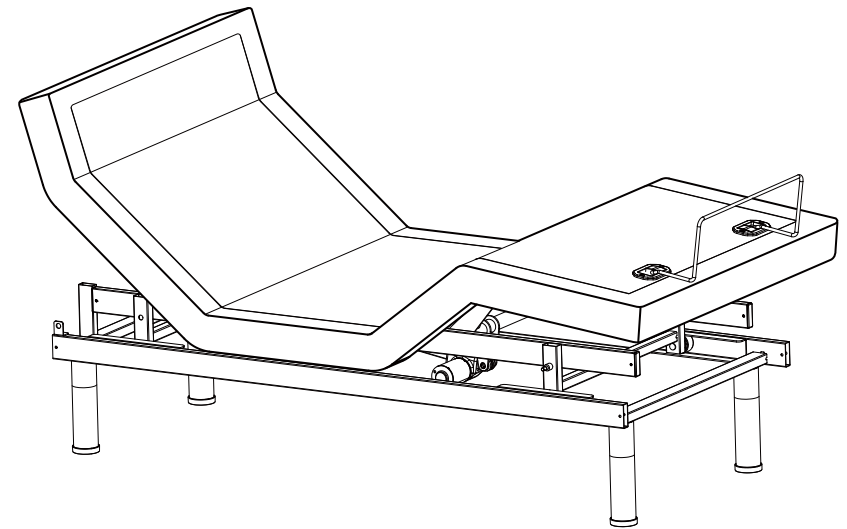

Adjustable Bed Base

CONTENTS

Safety & Warranty Warning.....	01
Parts List.....	02
Base Installation Guide.....	03
Electronics Quick Reference Guide.....	05
Synchronizing Twin XL Bases.....	06
Remote Control Pairing.....	06
Backlight Remote Control Guide.....	07
Device in Case of Power Failure.....	08
APP Control Guide (iPhone & Tablet).....	08
Troubleshooting.....	09
Warranty.....	10

Read **BEFORE** using this product

IMPORTANT SAFETY INSTRUCTIONS

When using electric equipment, basic precautions should always be followed, including the following:

DANGER – To reduce the risk of electric shock

Always unplug this adjustable bed base (base) from the electrical outlet before cleaning or servicing.

WARNING – To reduce the risk of burns, fire, electric shock, or injury:

1. Unplug from outlet before putting on or taking off parts.
2. Close supervision is necessary when this base is used by, or near children, invalids, or disabled persons.
3. Use this base only for its intended use as described in these instructions. Do not use attachments not recommended by the manufacturer.
4. Never operate this base if it has a damaged cord or plug, if it is not working properly, if it has been dropped or damaged, or dropped in water. Return the base to a service center for examination and repair.
5. Keep the cord away from heated surfaces.
6. Do not use this base outdoors.
7. Do not use this base near explosives.
8. Using the base with oxygen administering equipment other than the nasal masked type creates a possible fire hazard.
9. Do not operate where aerosol (spray) products are being used or where oxygen is being administered.
10. To disconnect, turn all controls to the off position, then remove plug from outlet.
11. Use caution when there are liquids in or around the base to ensure no spillage occurs. In case of spillage, stand in a dry, clean area of the floor and unplug the base immediately. Clean up the spill and allow the area around base to dry thoroughly before using the electric controls again. Do not eat or drink hot liquids while operating the base.
12. Do not allow any person or pet under the base at any time.
13. During base operation, make sure body is well positioned within the confines of the bed. Do not place extremities over the sides of the bed when operating base functions.
14. Only for household and similar use.

15. Never operate the base with the ventilation openings blocked. Keep the ventilation openings free of lint, hair, and the like.
16. Never drop or insert any object into any opening.
17. Remove remote control when not in use, and store out of reach of children.

SAVE THESE INSTRUCTIONS

WEIGHT LIMITS

Weight Restrictions: The recommended weight limit on this adjustable bed base is **750 pounds**. The base will structurally support this weight, provided it is evenly distributed across the base. The power base is not designed to support or lift the total weight in the head or foot sections alone. Exceeding this weight restriction could damage the base and/or cause injury and will void the warranty.

WARRANTY WARNINGS

Any opening or tampering with the control box, motors, or hand controls (with the exception of the battery compartment if equipped) will result in a void of the warranty.

PRODUCT RATING

The motors are not designed to operate continuously for more than 2 minutes in a 20 minute-time period or approximately 10% duty cycle. Attempting to circumvent or exceed this rating will shorten the life expectancy of the base and may void the warranty.

OPERATING INFORMATION

1. After base assembly is completed, operate remote control to ensure proper functions.
2. Keep moving parts free of obstruction during base operation (including sheets, clothing, tubing, wiring, and products using electric power cords).
3. Do not place entire weight on head or foot sections of the base, during repositioning and entering or exiting bed.

HOSPITAL DISCLAIMER

This base is NOT designed for hospital use and is NOT designed to meet hospital standards.

FREQUENCY: 2.4 GHz

FCC COMPLIANCE:

This device complies with Part 15 of the FCC Rules. Operation is subject to the following two conditions: (1) This device may not cause harmful interference; (2) this device must accept any interference received, including interference that may cause undesired operation.

To comply with the FCC RF exposure requirements, no change to the antenna or the device is permitted. Any change to the antenna or the device could result in the device exceeding the RF exposure requirement and void user's right to operate the device.



Parts List



All electronics and components that need to be installed are placed in boxes under the base or attached to the frame. Before discarding the packing materials, ensure that all the parts are accounted for.

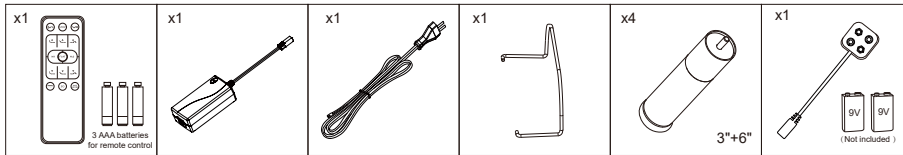

Remote Control Power Supply (29V 2.0A) AC Power Cord Mattress Retainer Bar Adjustable Legs Device in case of Power Failure

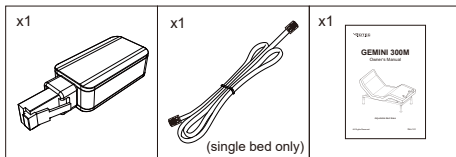

Bluetooth Receiver Synchronisation Cord Owner's Manual

Not Included

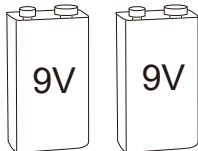

2 9V batteries for the device in case of power failure

NOTE: To avoid damage to the base, always open the carton while the base is in the flat position.

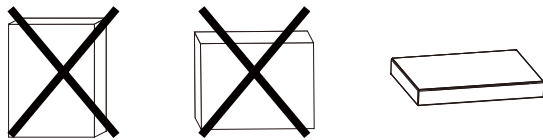

Base Installation Guide

Two people are required to set up the adjustable bed base.

1.

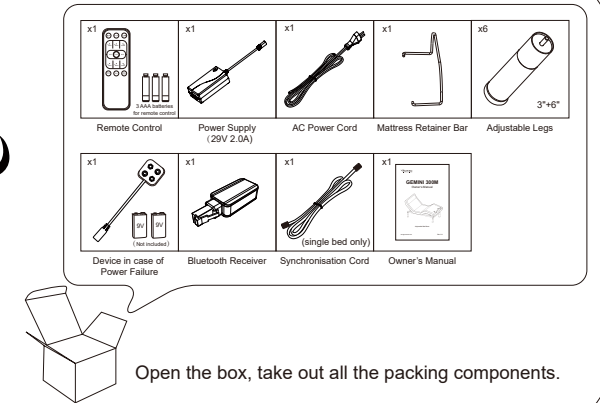
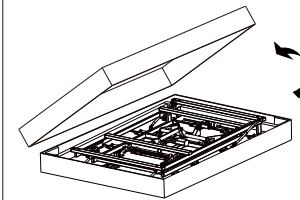

Open the box, take out all the packing components.

2.

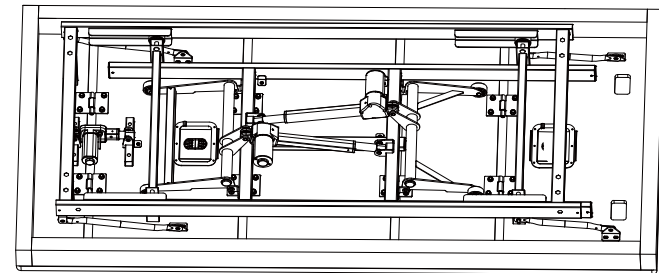

Remove the base from the box. Make sure the floor is clean. Lay the base flat on the floor.

3.

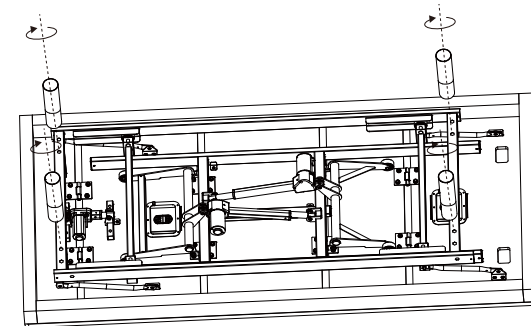

Install legs and tighten by hand.

4.

Mattress Retainer Block

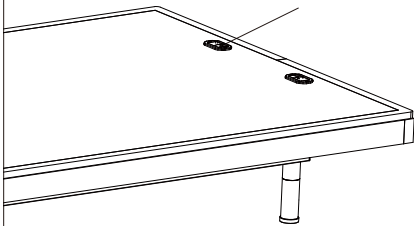

Carefully turn the base over so it is resting on its legs.

5.

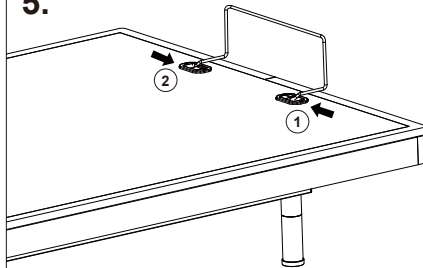

Slide the left side of the mattress retainer bar into the bracket. Pull the retainer bar to the opposite bracket and secure the right side.

6.

Connect the DC power cord to the power supply, uncoil the AC power cord and then connect it to the AC power source.

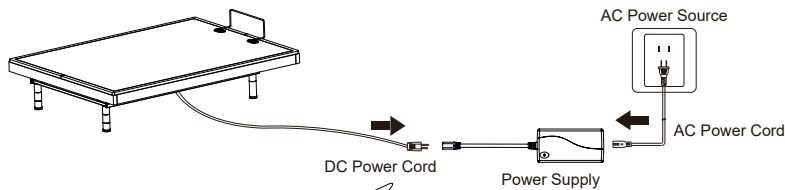

Connect the connectors as illustrated.

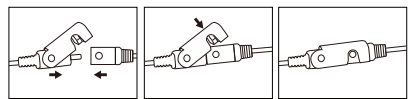

7.

Insert 3 AAA batteries into the remote control.

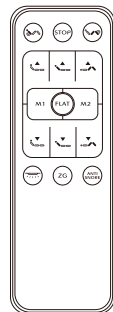
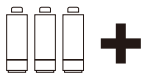

DONE!

Decorative Headboard

For efficiency, cost savings and safety reasons, Rotec recommends that users fix their headboard directly to the wall (material not included).

Electronics Quick Reference Guide

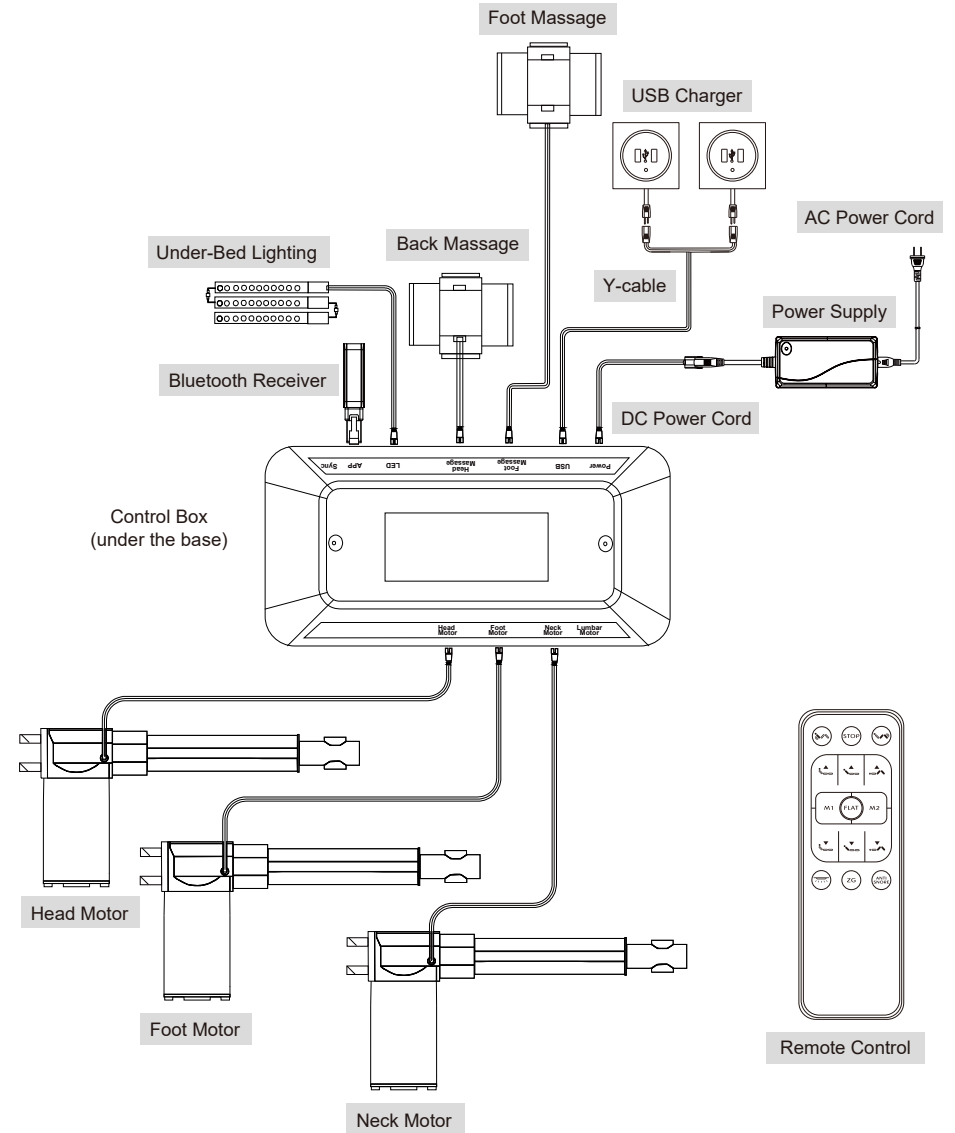

Synchronizing Twin XL Bases

If simultaneous operation of two twin XL bases is desired, use the synchronisation cord to connect the electronics of both bases together.

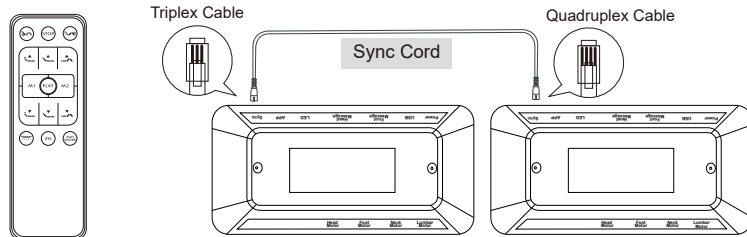

Remote control

STEP 1: Unplug bases from the power source.

STEP 2: Connect the male ends of the sync cord to the female sync plugs of the control boxes (Refer to illustration above).

STEP 3: Plug bases back into the power source.

STEP 4: Press and hold and buttons; a beep of the buzzer will be heard, and the backlight of the remote control will flash twice. Open the battery box and toggle the switch to "Central" position first, next press and hold "FLAT" until you hear a beep from each buzzer on the control box, which means the two bases can be synchronized with one remote control.

NOTE: To control the two bases separately without removing the sync cord, open the control remote battery box and flip the switch to the "A" or "B" position.

Attention: (1) If you want to toggle from "A" or "B" to "Central" position to realize sync control, please press and hold "Flat" again until you reach a flat position. (2) The quadruplex cable is in master control when synchronizing and the Bluetooth must be plugged in the master control box. (3) The interval must be more than 4 s between plug in and plug out the sync cord.

Remote Control Pairing

The original remote that comes in the box is already paired to the adjustable base. Just wait 30s after the adjustable base is powered on, then the remote can be used normally. In the event that the remote is not paired with the adjustable base, follow the steps below.

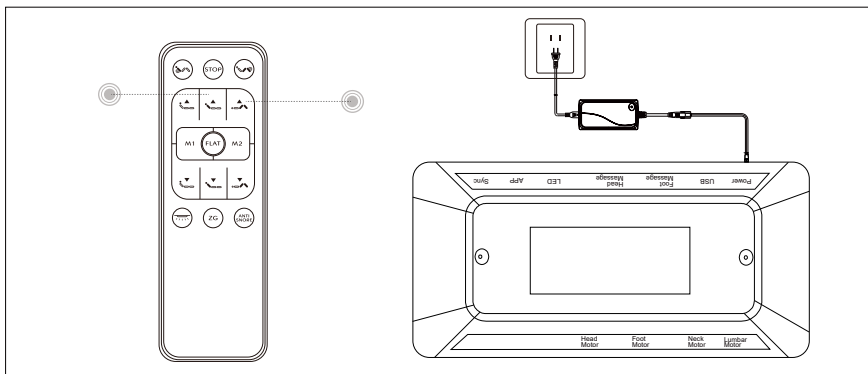

1. Unplug the adjustable base from the power source, wait 60s, then power it on.
2. Press and hold at the same time.
3. You will hear a beep sound of the buzzer and the backlit light of the wireless remote flashes two times, which means the pairing is successful.

NOTE: Please complete the repairing within 30s after the foundation is powered on.

Backlight Wireless Remote Control Guide

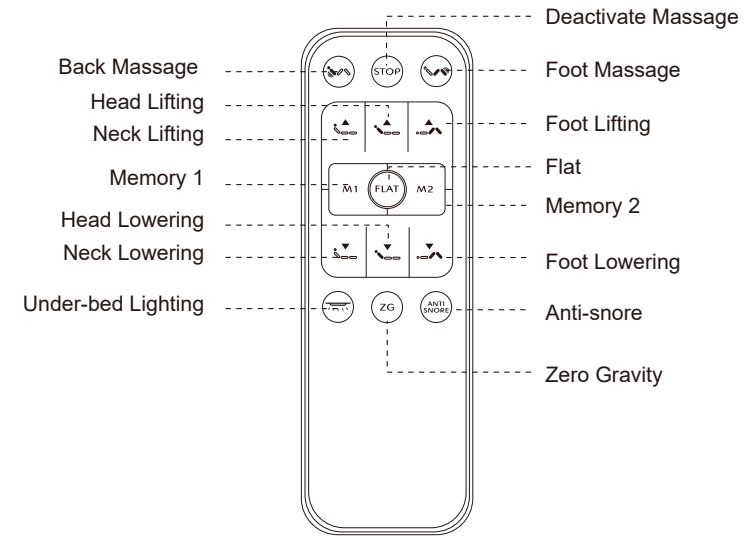

One Touch Buttons



Press to adjust the base to "Memory 1" or "Memory 2".

STEP 1: Operate the remote to your desired position.

STEP 2: Press and hold "M1" or "M2" for more than 3s till hearing a beep sound of the buzzer on the control box and the backlit light of the wireless remote flashes two times, which means the memory position is saved.



Press to turn on the Back/Foot Massage.

Press the button once to increase one intensity level, there are 3 intensity levels available. When it is in the 3rd level, press the button again and the massage will turn off. The massage motor will turn off automatically after 30 min.



Press to turn off the massage.



Press to elevate the foot section slightly higher than the chest, in effect, allowing the blood to flow back to the heart to help reduce stress and fatigue.



Press to adjust the base to the flat position.





Press to turn on the under-bed lighting. The light will turn off if the button is not pressed within 10 min.



Press to adjust the base to the pre-programmed anti-snore position that let you get a restful night.

Adjustment

-  HEAD UP/DOWN BUTTONS
 Press and hold to lift or lower the HEAD section.
-  FOOT UP/DOWN BUTTONS
 Press and hold to lift or lower the FOOT section.
-  NECK UP/DOWN BUTTONS
 Press and hold to lift or lower the NECK section.

Device in Case of Power Failure

To use if needed

When there is an electric power failure, the included device and two batteries 9V 2.0A (not included) can be used to flatten the base.

- (1) Put the batteries in the device.
- (2) Unplug the power cord from the outlet and plug the power cord into the device.
- (3) Adjust the base.

1. Device with 2 9V batteries



2.

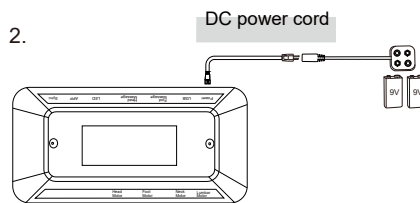

How To Reset

- STEP 1: Unplug adjustable base from the power source.
- STEP 2: Plug adjustable base back into the power source after 60 seconds.
- STEP 3: Automatic reset is completed.

APP Control Guide (Dream Motion)

Download free to control the bed from a smartphone or a tablet.

IOS

Open the APP Store, search for the keyword "Dream Motion" to download the app.  Dream Motion

ANDROID

Open the Google Play to search for the keyword "Dream Motion" and download the app.  Dream Motion

Please follow the instructions for use in the APP.

Troubleshooting

If the adjustable base fails to operate, search for the symptoms and possible solutions below.

<p>The adjustable base does not respond when the remote control is used. Remote control led light is on and appears to be normal.</p>	<ul style="list-style-type: none"> • Make sure the remote control is paired with the base. • Check that the power cord is plugged into a working and grounded electrical outlet. Unplug the power cord from the outlet. After 30 seconds, plug it back in. Press any button on the remote control and hold until light on the remote control turns on.
<p>None of the features or functions of the base activates.</p>	<ul style="list-style-type: none"> • Make sure the remote control is paired with the base. • Check that the power cord is plugged into a working and grounded electrical outlet. Unplug the power cord from the outlet. After 30 seconds, plug it back in. Press any button on the remote control and hold until light on the remote control turns on. • Check that the surge protection device or electrical outlet is not defective. Test the outlet by plugging in another working appliance.
<p>Head or foot lift function works to lift the base, but it does not return it to the flat position.</p>	<ul style="list-style-type: none"> • Your base may be obstructed, preventing smooth operation. Remove obstructions from around and under the base. • Check that the head section is not too close to the wall. • If a headboard is installed, check that it is not too close to the edge of the mattress. Make sure there is enough distance between the headboard bracket and the mattress.
<p>Head or foot lift function has minor interference during operation.</p>	<ul style="list-style-type: none"> • Check the batteries in the remote control. Replace with new batteries, if necessary. • Make sure that you are following the duty cycle of the motors. Do not operate for more than two minutes over a 20-minute period or approximately 10% duty cycle. • Press the lift buttons firmly and accurately. • The remote control may be experiencing common radio frequency interference from other radio transmitting devices. Wait several seconds and then try pressing the lift buttons again.
<p>A clicking noise is heard under the base when raising or lowering the sections.</p>	<ul style="list-style-type: none"> • This is normal. The lift motors click when they are engaged. No action is required.
<p>Excessive massage motor noise.</p>	<ul style="list-style-type: none"> • If the base is located on hard surface flooring, place carpet pieces or rubber pieces (not included) under each leg. • Using the remote control, raise the head, foot or neck section slightly to realign the lift/lower mechanisms with the base support platform. • Make sure that your base is not positioned against a wall, nightstand, or other object that may cause the vibration or noise. • If the base is installed over a base frame, make sure that the massage motors are not causing the base frame (or base frame components) to vibrate. • Make sure that the headboard attachment hardware is properly tightened (if used).

Warranty

Congratulations! You have made an excellent choice by purchasing a Rotec electric adjustable bed base.

To honor the warranty, please keep your proof of purchase (invoice).

For a service call, please provide the information requested on the invoice and the serial number located under the bed (sequence of 3 letters and multiple numbers under the bar code).

Full One (1) Year Warranty

Our product is warranted against defects in materials or workmanship for a period of one year from the date of purchase by the original purchaser. During the first year, Rotec or its distributor will repair or replace, at no cost to the original purchaser, any defective part. This includes all authorized labor costs incurred with the repair or replacement of any part found to be defective.

Two (2) Year Warranty – Hand Control and Electronic Components

Our product has a two-year, full replacement warranty on parts, labor and authorized transportation on the hand control and electronic components following the purchase date.

Five (5) Year Warranty – Electric and Massage Motors

Our product has a five-year, full replacement warranty on parts, labor and authorized transportation on the electric and massage motors following the purchase date.

Twenty-five (25) Year Warranty – Frame

Our product has a twenty-five-year warranty on the steel frame (structural defects) following the purchase date.

Other terms and conditions

- Rotec International reserves the right to substitute equal or superior quality materials during repairs or replacements. The material replaced and covered by this warranty does not allow one to benefit from a new warranty. It only benefits from the original warranty. For further information, contact our technical services.
- This warranty does not cover damages caused by negligence or inappropriate use. Rotec International will not be held responsible for any other warranty offered by any person, firm or company, to the exclusion of the one stipulated above.
- This warranty gives you specific legal use rights and is only valid for the original purchaser or for anyone who would have received it as a gift. You can also reach us at service@rotecbeds.com or 1-800-358-6440.